



# Image Formation III

## Chapter 1 (Forsyth&Ponce)

### Cameras “*Lenses*”

Guido Gerig

CS 6320 S2013

(slides modified from Marc Pollefeys,  
UNC Chapel Hill)



# Pinhole size / aperture

How does the size of the aperture affect the image we'd get?

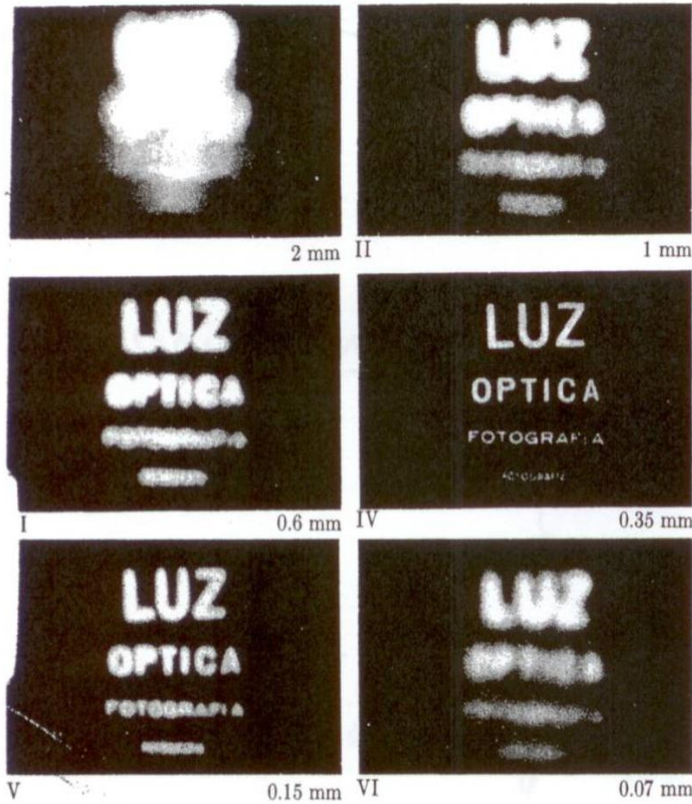

Larger



Smaller

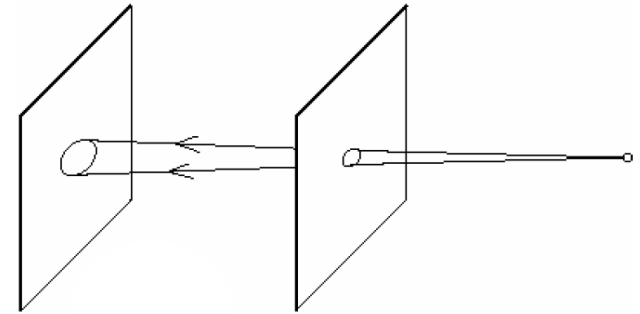
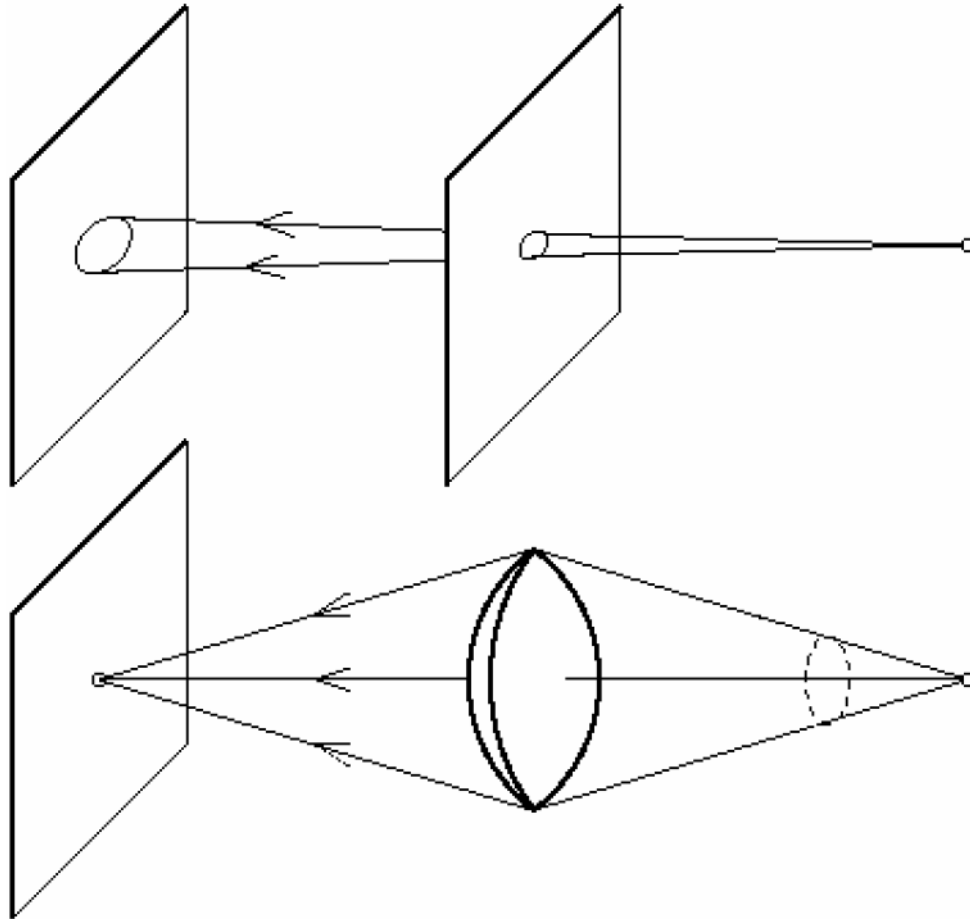

Fig. 5.96 The pinhole camera. Note the variation in image clarity as the hole diameter decreases. [Photos courtesy Dr. N. Joel, UNESCO.]



# Pinhole vs. lens





# Adding a lens

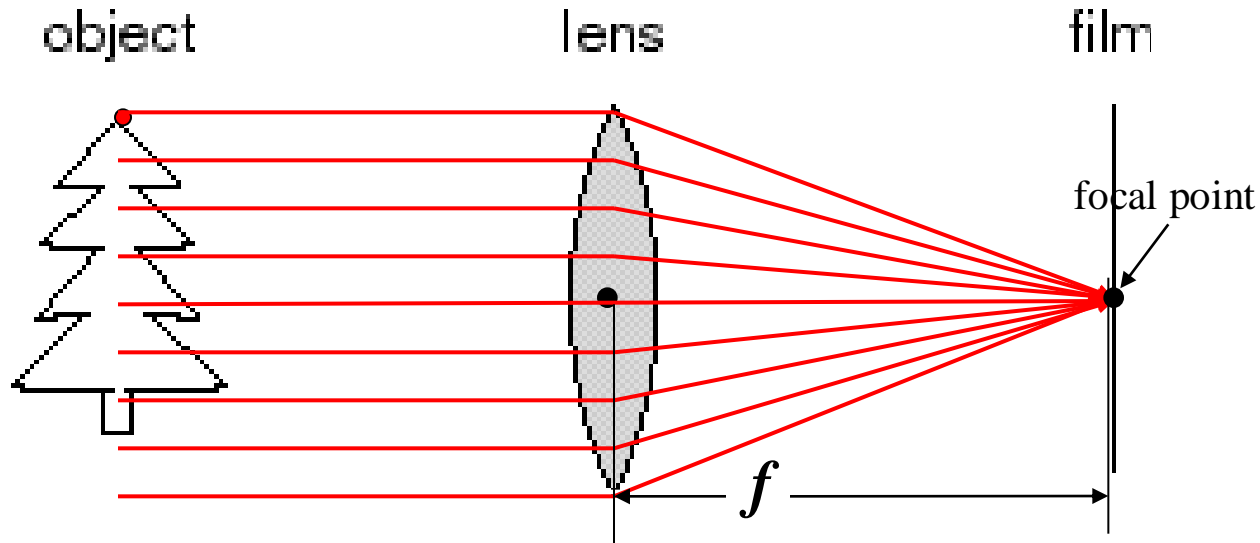

A lens focuses light onto the film

- Rays passing through the center are not deviated
- All parallel rays converge to one point on a plane located at the *focal length*  $f$



# Cameras with lenses

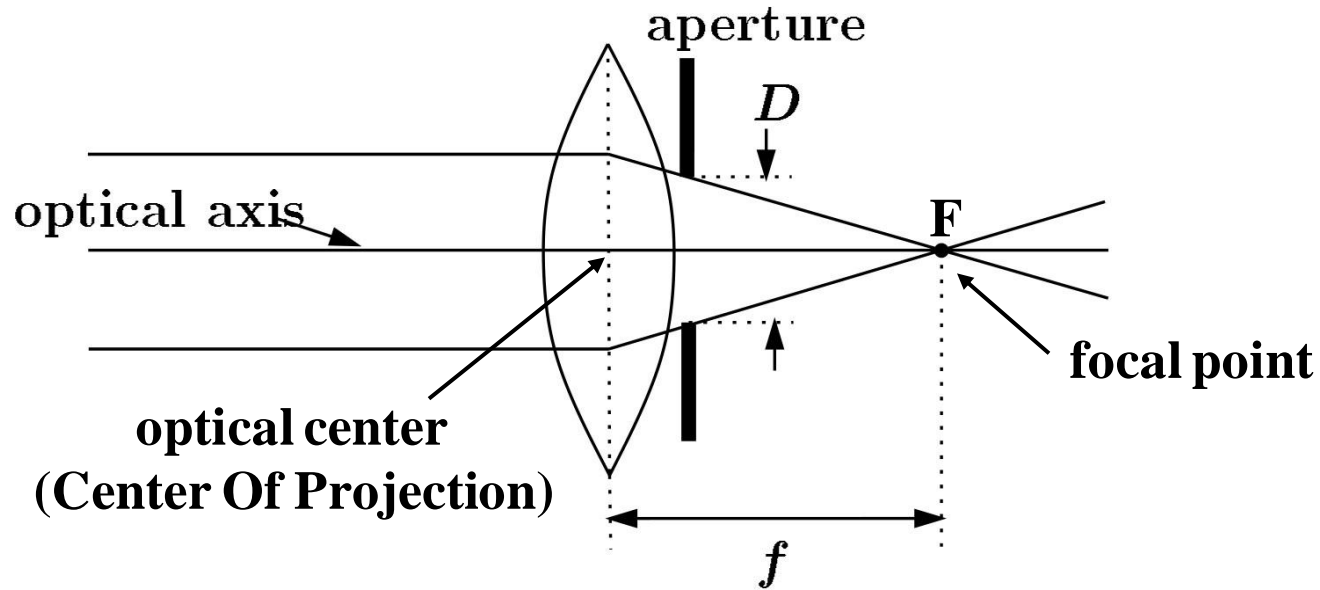

- A lens focuses parallel rays onto a single focal point
- Gather more light, while keeping focus; make pinhole perspective projection practical



# Lenses

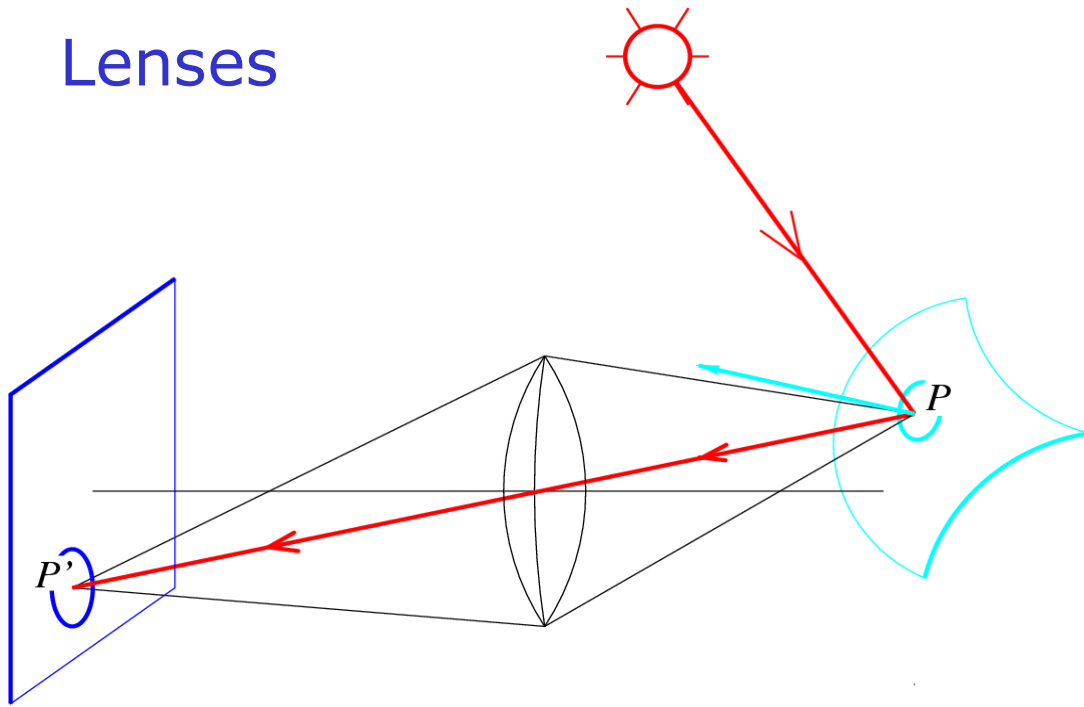

## Snell's law

$$n_1 \sin \alpha_1 = n_2 \sin \alpha_2$$

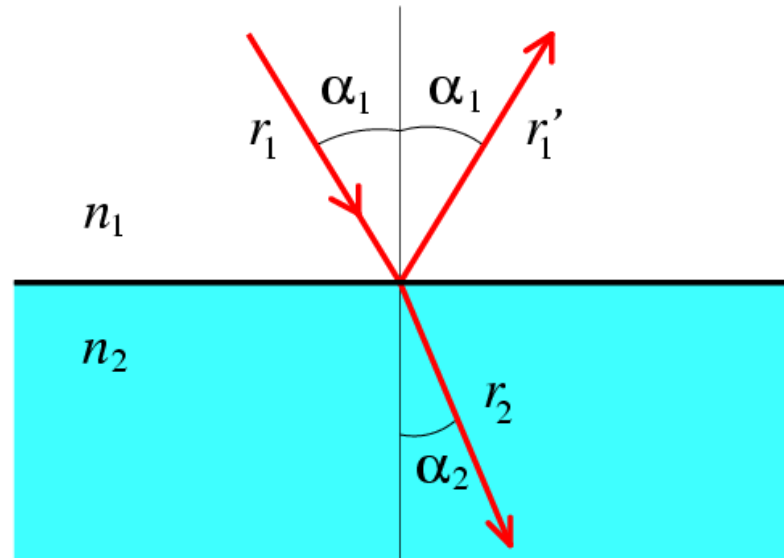

# Paraxial (or first-order) optics

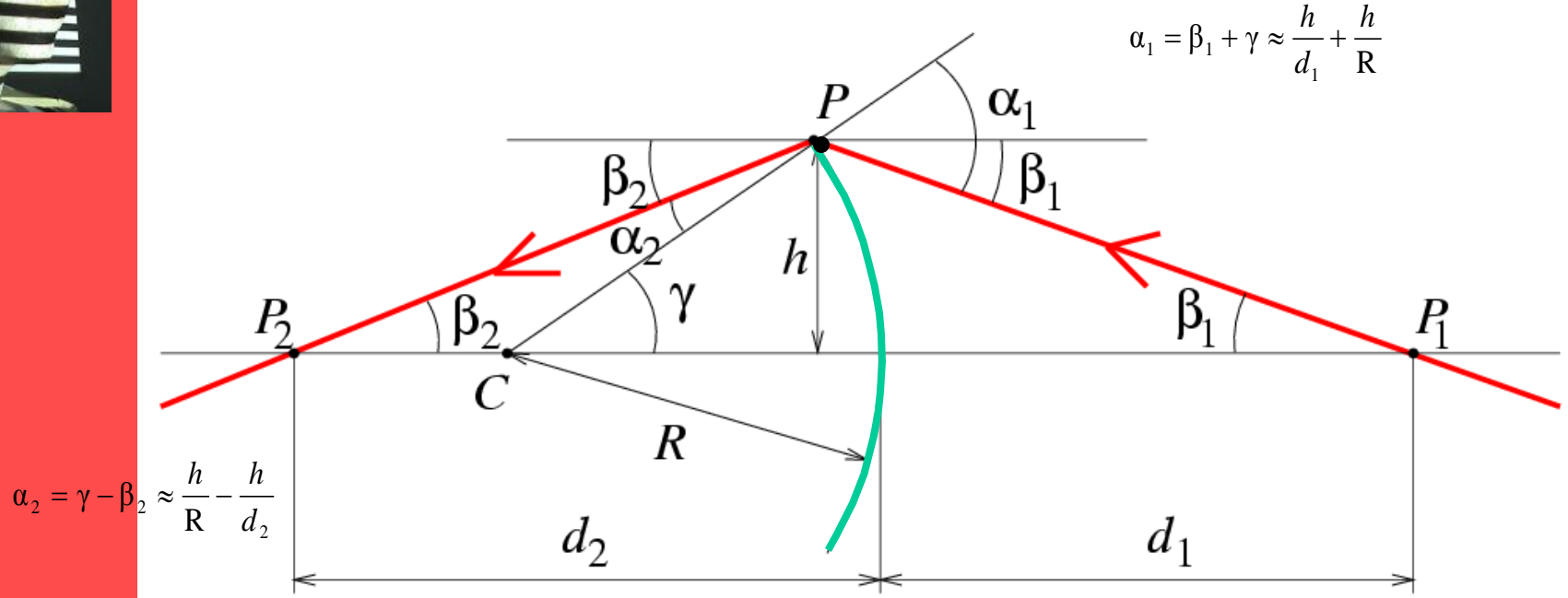

Snell's law:

Small angles:

$$n_1 \left( \frac{h}{d_1} + \frac{h}{R} \right) = n_2 \left( \frac{h}{R} - \frac{h}{d_2} \right)$$

$$n_1 \sin \alpha_1 = n_2 \sin \alpha_2 \quad \longrightarrow \quad n_1 \alpha_1 \approx n_2 \alpha_2 \quad \longrightarrow$$

$$\frac{n_1}{d_1} + \frac{n_2}{d_2} = \frac{n_2 - n_1}{R}$$

# Thin Lenses

spherical lens surfaces; thickness  $\ll$  radii; same refractive index on both sides; all rays emerging from  $P$  and passing through the lens are focused at  $P'$ . Let  $n_1=1$  (vacuum) and  $n_2=n$ .

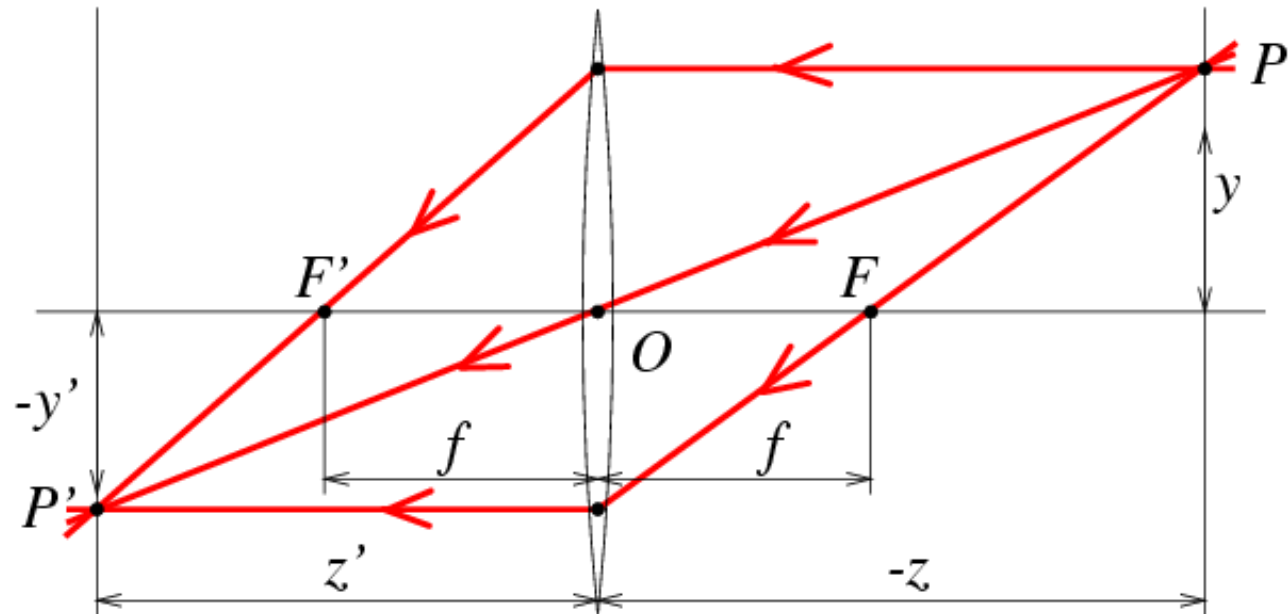

$$\begin{cases} x' = z' \frac{x}{z} \\ y' = z' \frac{y}{z} \end{cases}$$

where

$$\frac{1}{z'} - \frac{1}{z} = \frac{1}{f}$$

and

$$f = \frac{R}{2(n-1)}$$





# Thick Lens

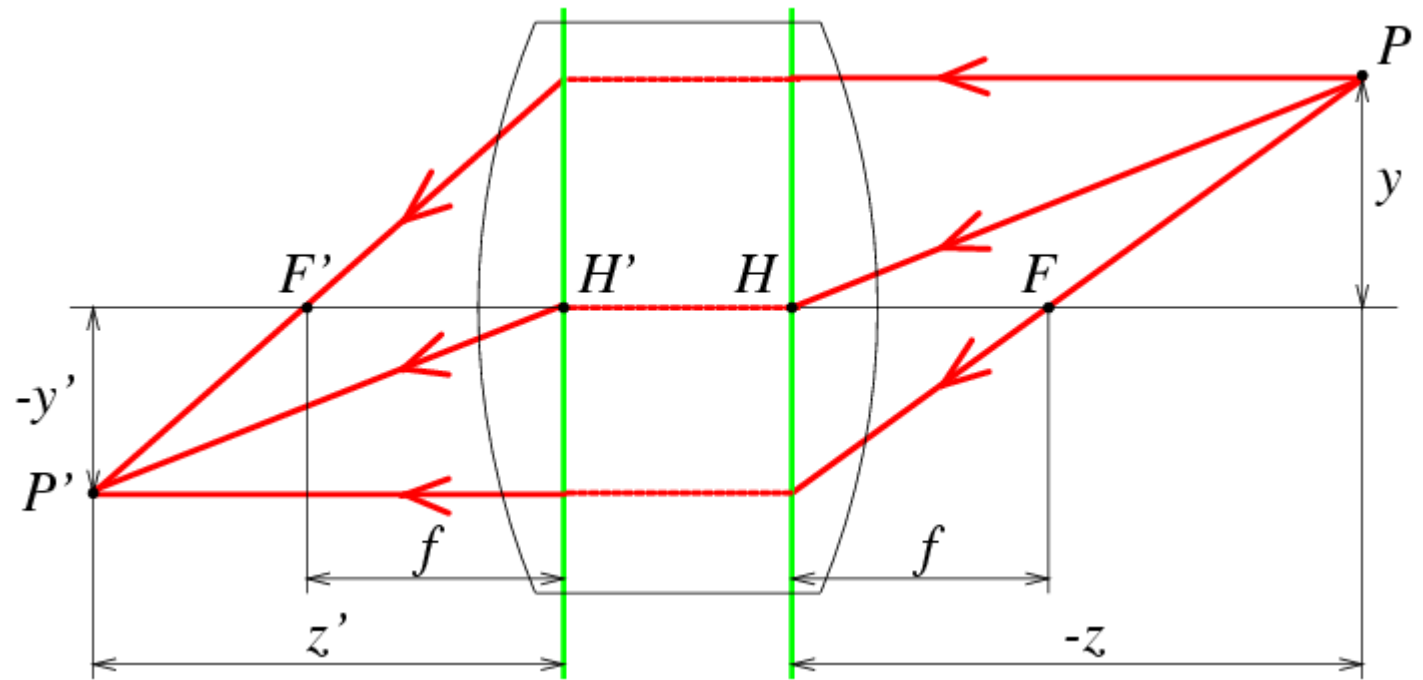

# Focus and depth of field





# The depth-of-field

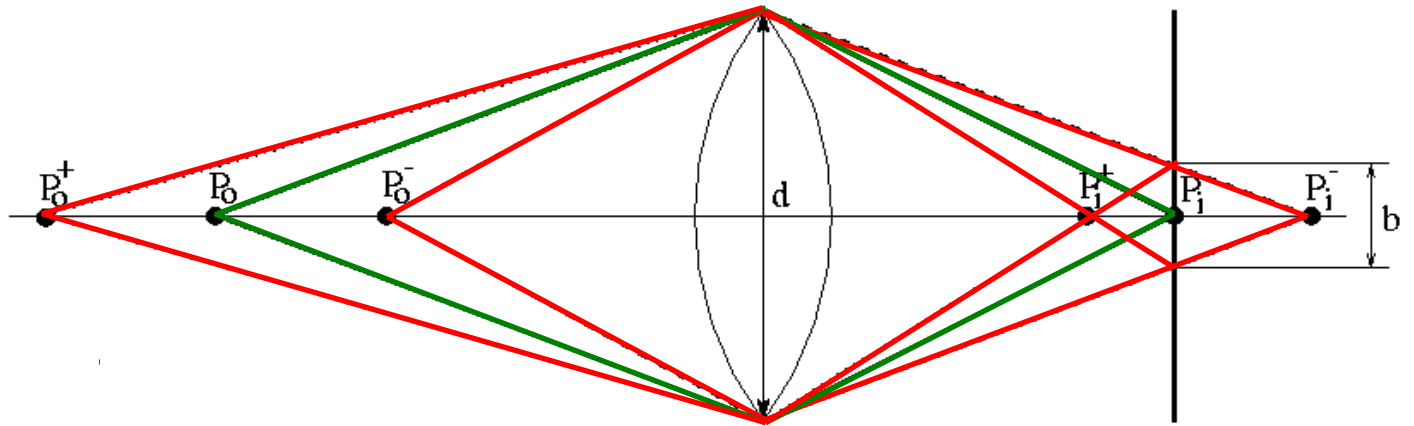

# Focus and depth of field

- Depth of field: distance between image planes where blur is tolerable

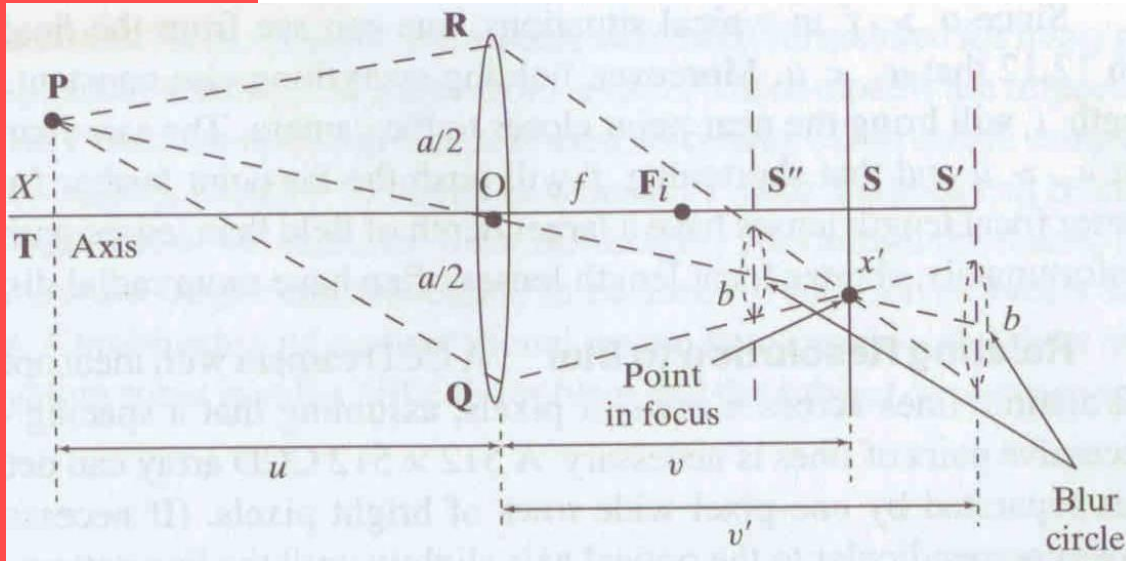

Thin lens: scene points at distinct depths come in focus at different image planes.

(Real camera lens systems have greater depth of field.)

← "circles of confusion" →

# Focus and depth of field

- How does the aperture affect the depth of field?

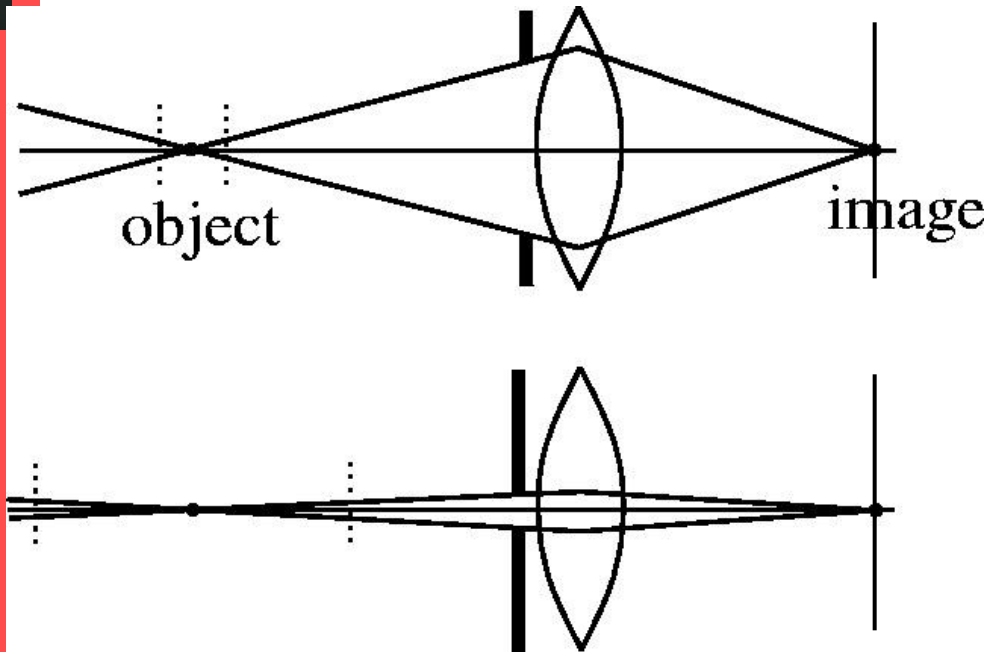

- A smaller aperture increases the range in which the object is approximately in focus



# The depth-of-field

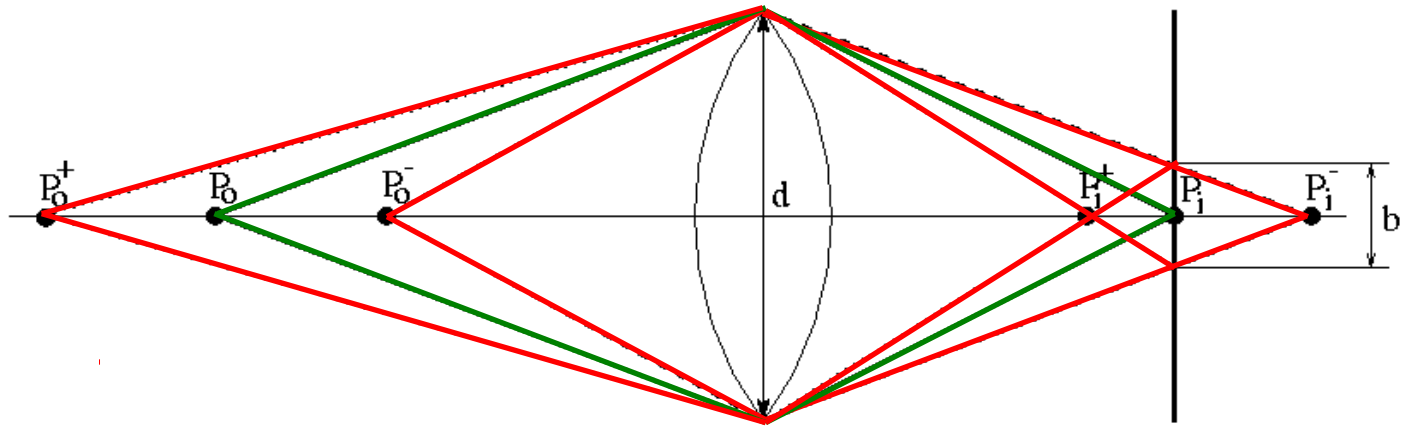



## The depth-of-field

yields  $Z_o^- = f \frac{|Z_i^-|}{|Z_i^-| - f}$

$$Z_o^- = f \frac{d Z_o}{b Z_o + f (d - b)}$$

$$\Delta Z_o^- = Z_o - Z_o^- = \frac{Z_o (Z_o - f)}{Z_o + f d / b - f}$$

Similar formula for  $\Delta Z_o^+ = Z_o^+ - Z_o$





## The depth-of-field

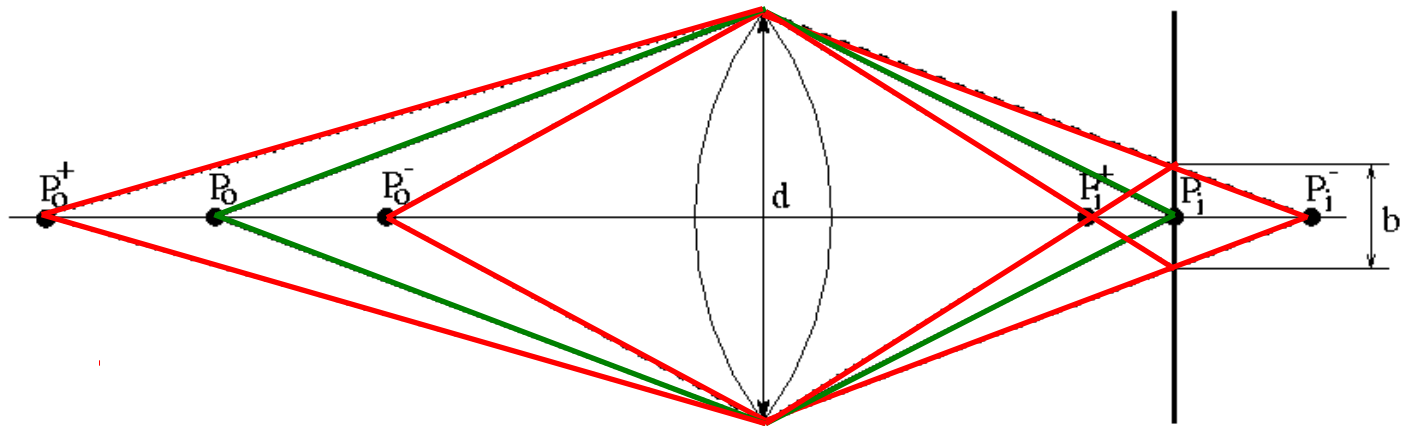

$$\Delta Z_0^- = Z_0 - Z_0^- = \frac{Z_0(Z_0 - f)}{Z_0 + f d / b - f}$$

decreases with  $d+$ , increases with  $Z_0+$   
strike a balance between incoming light and  
sharp depth range







## Deviations from the lens model

3 assumptions :

1. all rays from a point are focused onto 1 image point
2. all image points in a single plane
3. magnification is constant

deviations from this ideal are *aberrations*





# Aberrations

2 types :

1. geometrical

2. chromatic

*geometrical* : small for paraxial rays

study through 3<sup>rd</sup> order optics  $\sin(\theta) \approx \theta - \frac{\theta^3}{6}$

*chromatic* : refractive index function of wavelength





## Geometrical aberrations

- ❑ spherical aberration
- ❑ astigmatism
- ❑ distortion
- ❑ coma

aberrations are reduced by combining lenses

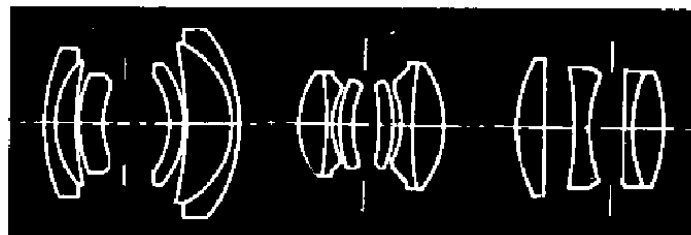



# Spherical aberration

rays parallel to the axis do not converge

outer portions of the lens yield smaller focal lengths

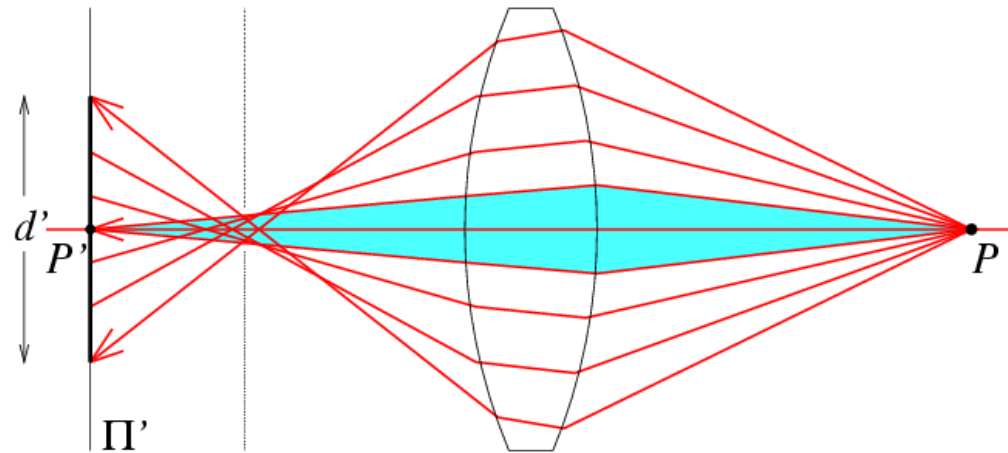



# Astigmatism

Different focal length for inclined rays

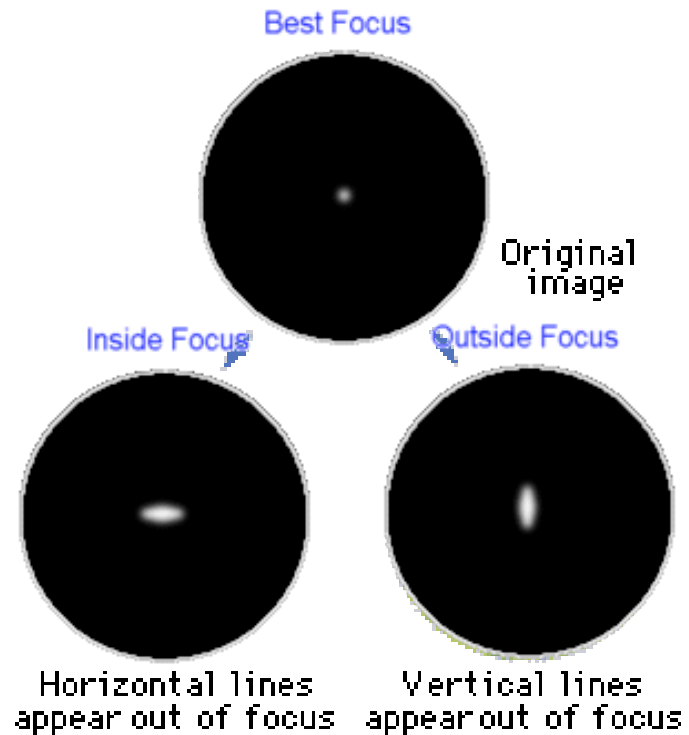
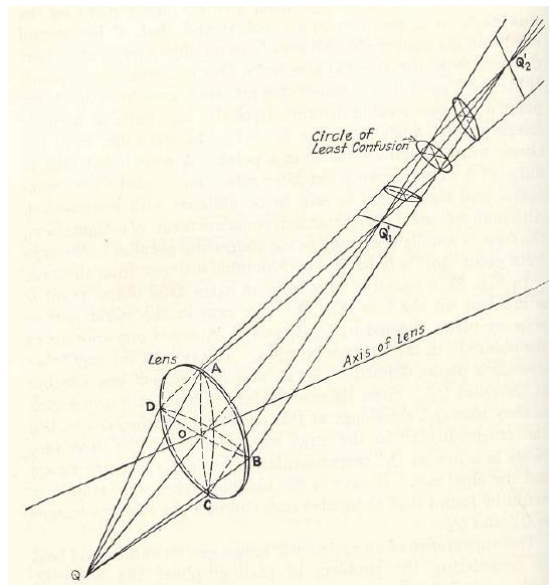
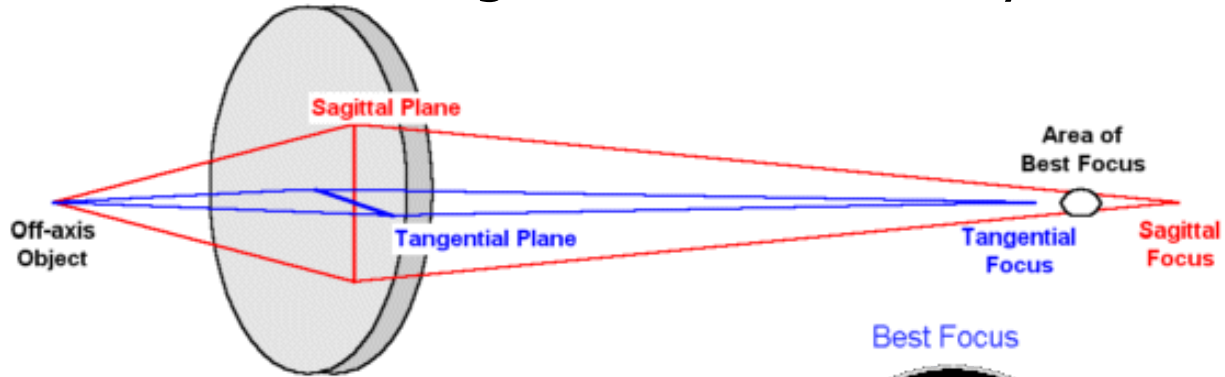

# Distortion

magnification/focal length different  
for different angles of inclination



pincushion  
(tele-photo)



barrel  
(wide-angle)



Can be corrected! (if parameters are know)



# Coma

point off the axis depicted as comet shaped blob

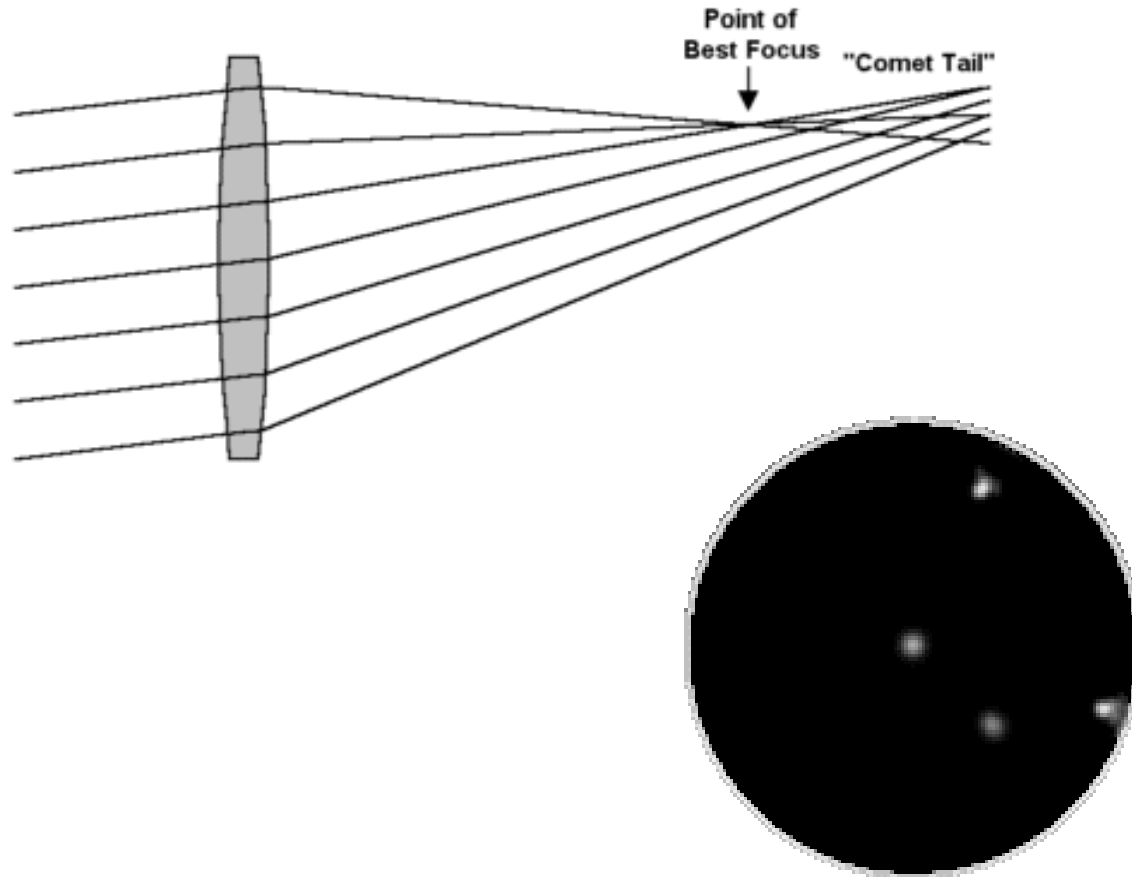



# Chromatic aberration

rays of different wavelengths focused in different planes

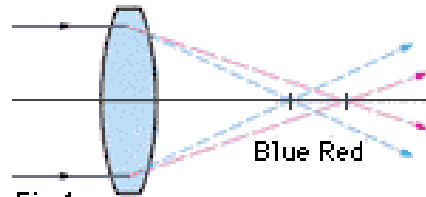

Fig.1  
Axial chromatic aberration

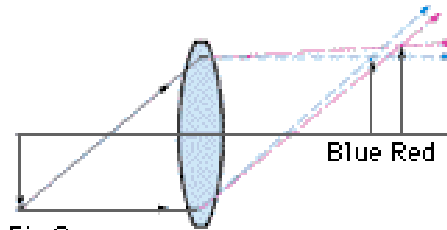

Fig.2  
Magnification chromatic aberration



The image is blurred and appears colored at the fringe.

cannot be removed completely

sometimes *achromatization* is achieved for more than 2 wavelengths

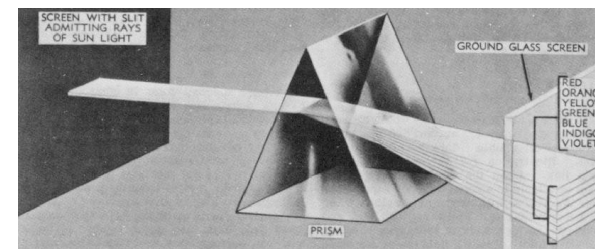





# Vignetting

